

MaxMotion

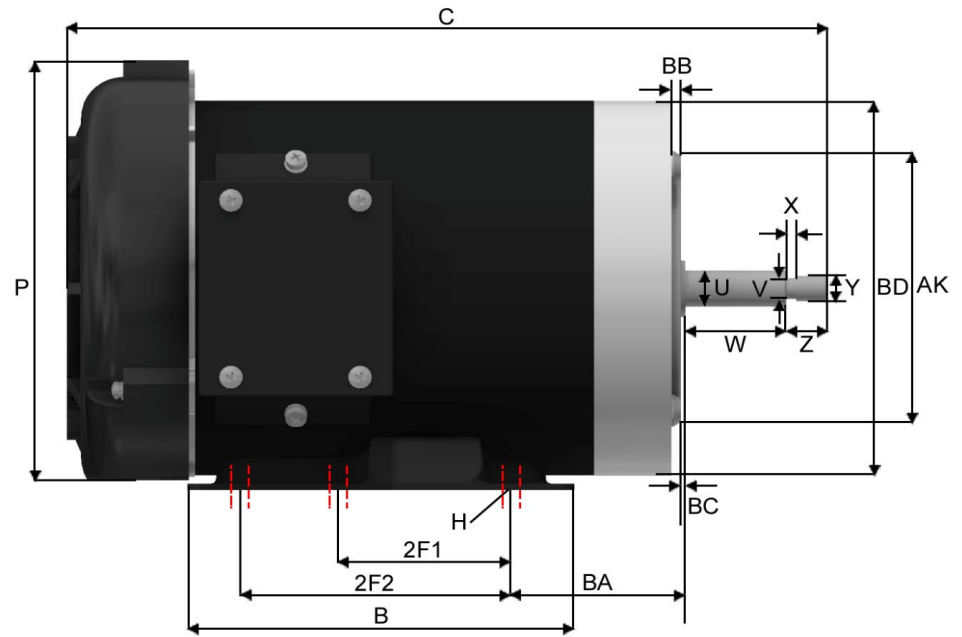
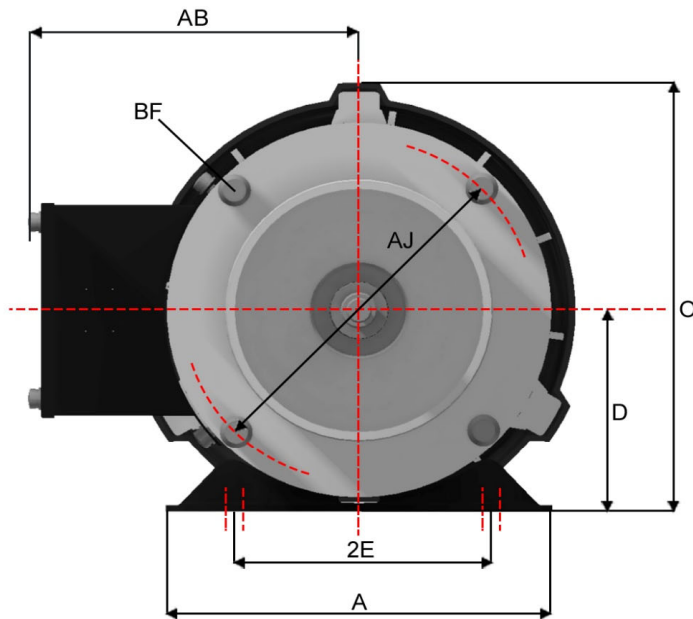

Version: 1WTI		Revised: 20-04-2020		HP	RPM	FRAME	ENCLOSURE	MPRP/MQRP-302J					
Customer is responsible in determining that MEP product will fit/perform suitably in the intended application				3	3485	56J	TEFC						
A	B	C	D	2E	2F1	2F2	H	O	P	U	V	W	X
6.5	6.50	14.45	3.50	4.88	3.00	5.00	0.34	7.44	7.25	0.625	0.372-0.362	1.693	0.118
Y		Z	AB	AJ	AK	BA	BB	BC	BD	BF			
7/16-20 UNF-2A R H		0.689	5.47	5.875	4.50	2.75	0.16	0.031	6.45	4*3/8-16			